

# 1 BtoB package

Selmi Package 15 September 2021 / 15 December 2021



ROASTER 106



WINNOWER



GRINDER



VIBRA



MICRON 25



CONCA

technical drawing

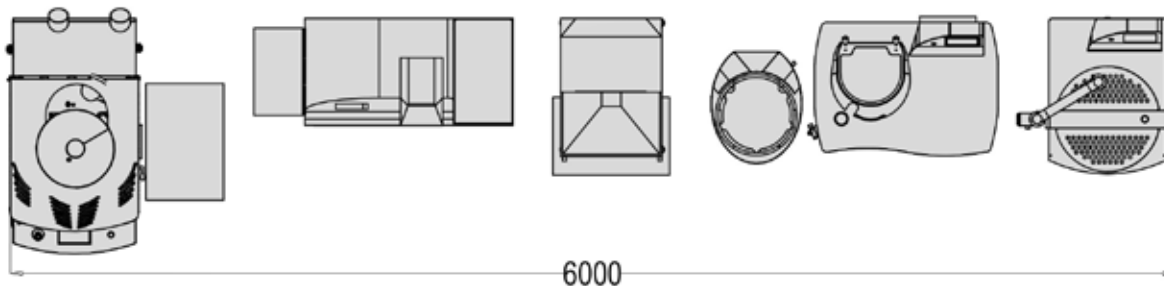

Total price ex-works

€ 58.000,00

# 2 Spreadable Cream Line

Selmi Package 15 September 2021 / 15 December 2021



VIBRA



MICRON 25

technical drawing

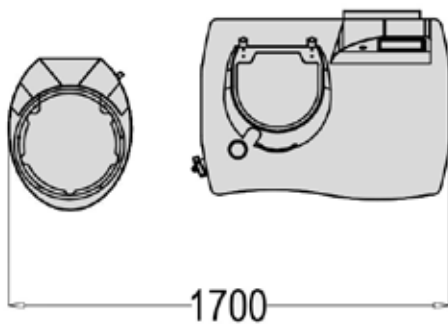

Total price ex-works

**€ 15.000,00**

# 3 One Shot

Selmi Package 15 September 2021 / 15 December 2021



TUTTUNO

technical drawing

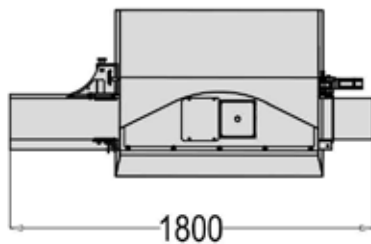

Total price ex-works

**€ 33.000,00**

# 4 One Shot + Mould loader + Vibra

almi Package 15 September 2021 / 15 December 2021



TUTTUNO

VIBRA

technical drawing

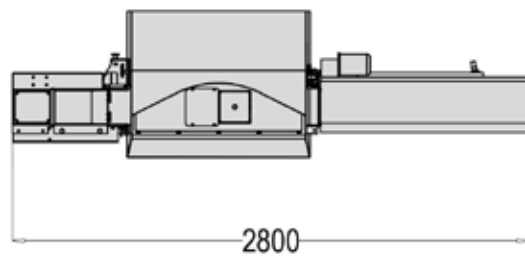

Total price ex-works

**€ 44.000,00**

# 5 One Shot + Mould loader + Vibra + Spider Selmi Package 15 September 2021 / 15 December 2021



technical drawing

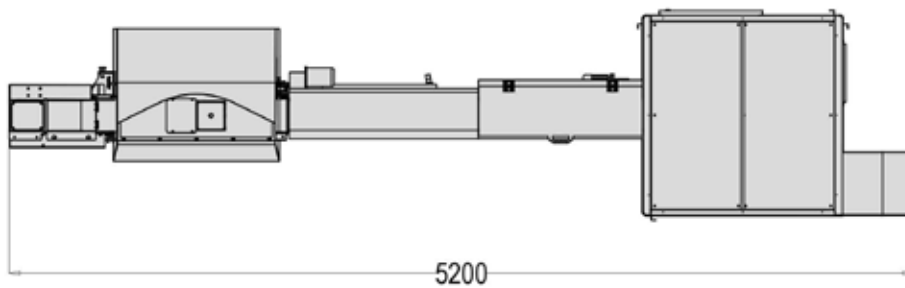

Total price ex-works

**€ 79.000,00**

# 6 One Shot Line

Selmi Package 15 September 2021 / 15 December 2021



TUTTUNO

VIBRA

SPIDER

DEMOULDING

technical drawing

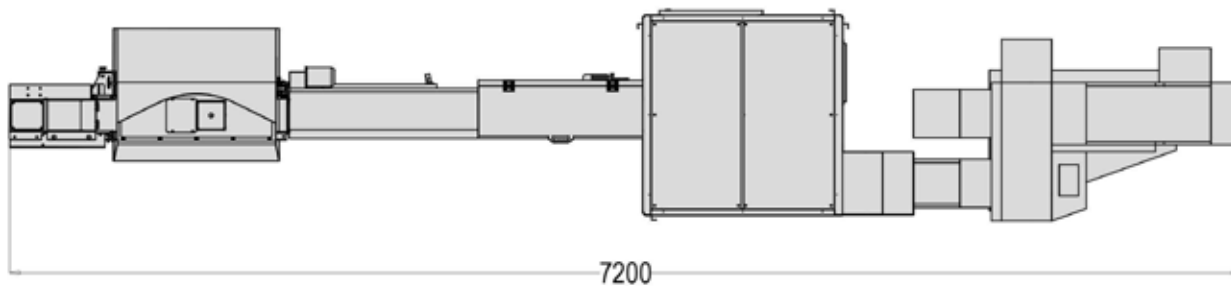

Total price ex-works

**€ 99.000,00**

# 7 Enrobing Line

Selmi Package 15 September 2021 / 15 December 2021



TOP EX

R300

TUNNEL 5 mt - 300 mm BELT

DETACHMENT



technical drawing

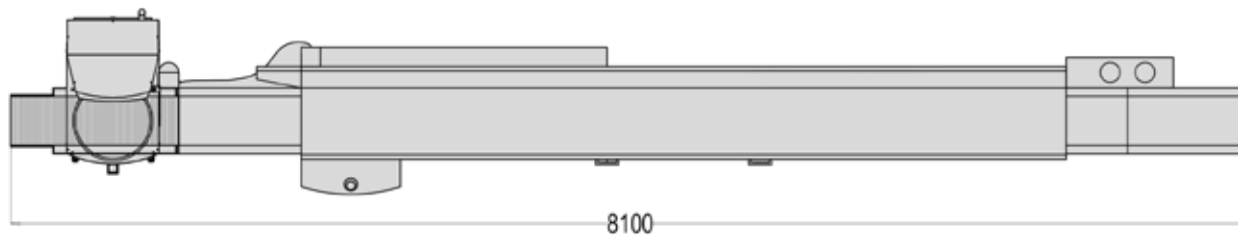

8100

Total price ex-works

**€ 45.000,00**

# 8 Cluster Task

Selmi Package 15 September 2021 / 15 December 2021



TOP EX CLUSTERS

TUNNEL 5 mt - 400 mm BELT

DETACHMENT



technical drawing

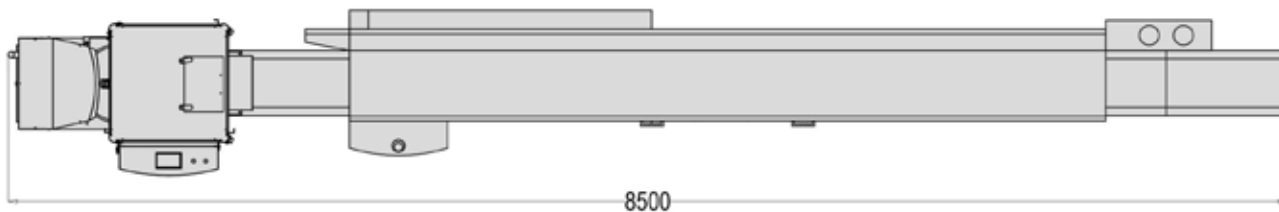

Total price ex-works

€ 70.000,00



# 9 Cluster Trays

Selmi Package 15 September 2021 / 15 December 2021



CLUSTERS



TRAYS VIBRATION



technical drawing

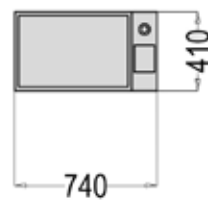
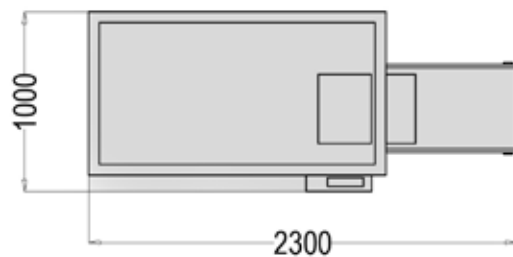

Total price ex-works

**29.500,00**

# 10 Comfit + Spray + Plus Ex

Selmi Package 15 September 2021 / 15 December 2021



PLUS EX



COMFIT



SPRAY



technical drawing

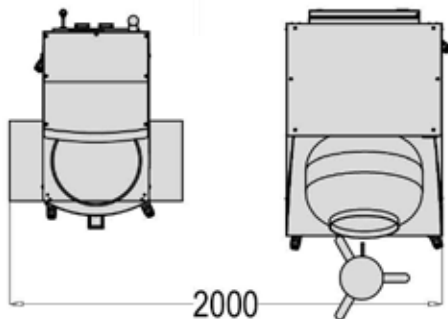

Total price ex-works

€ 19.000,00

# 11 Tuttuno Moulding + Enrobing Line

Selmi Package 15 September 2021 / 15 December 2021



TUTTUNO  
MOULD LOADER  
VIBRA  
ELEVATOR AND PUSHER

TUNNEL 8 MT - BELT 320 MM - DOUBLE LAYER

TOP EX  
ENROBING BELT



technical drawing

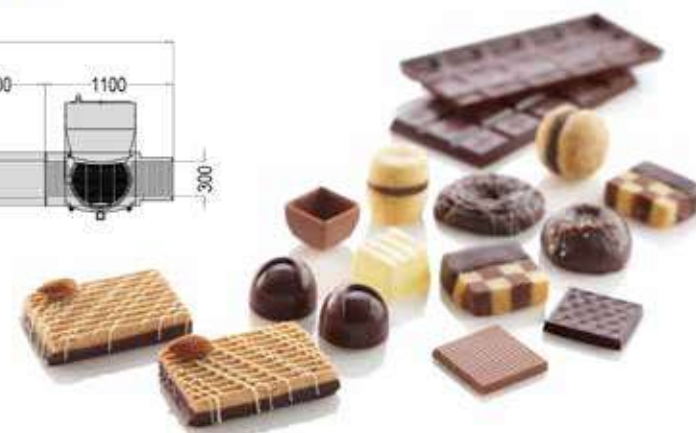
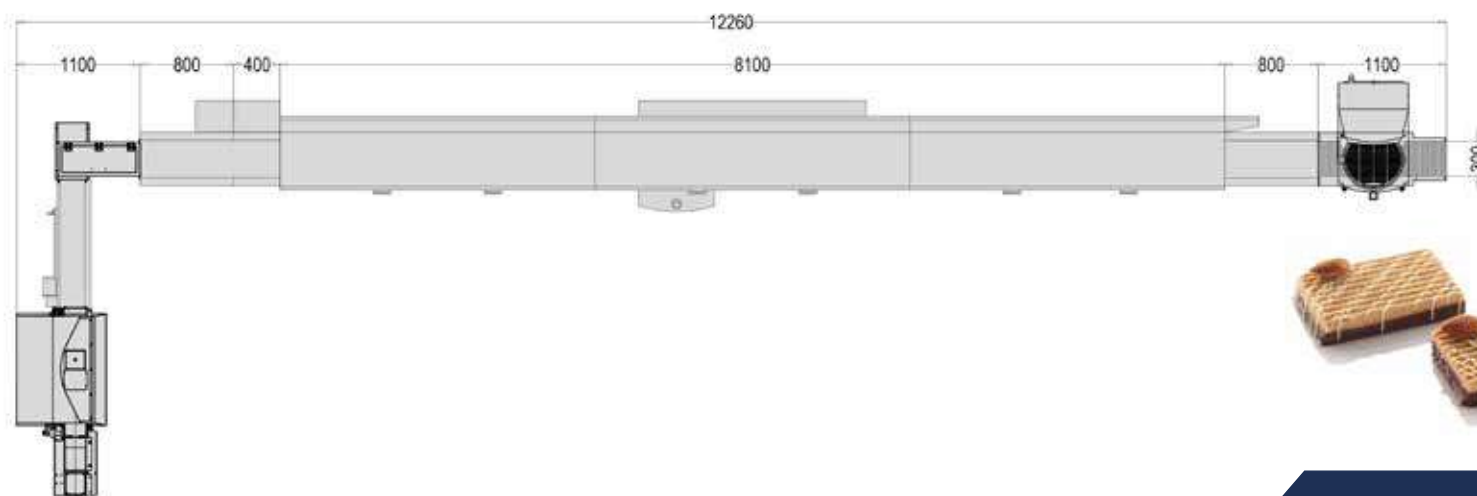

Total price ex-works **€ 110.000,00**

# 12 Premium Lab

Selmi Package 15 September 2021 / 15 December 2021

## Tuttuno Line

TUTTUNO  
MOULD LOADER  
VIBRA  
SPIDER

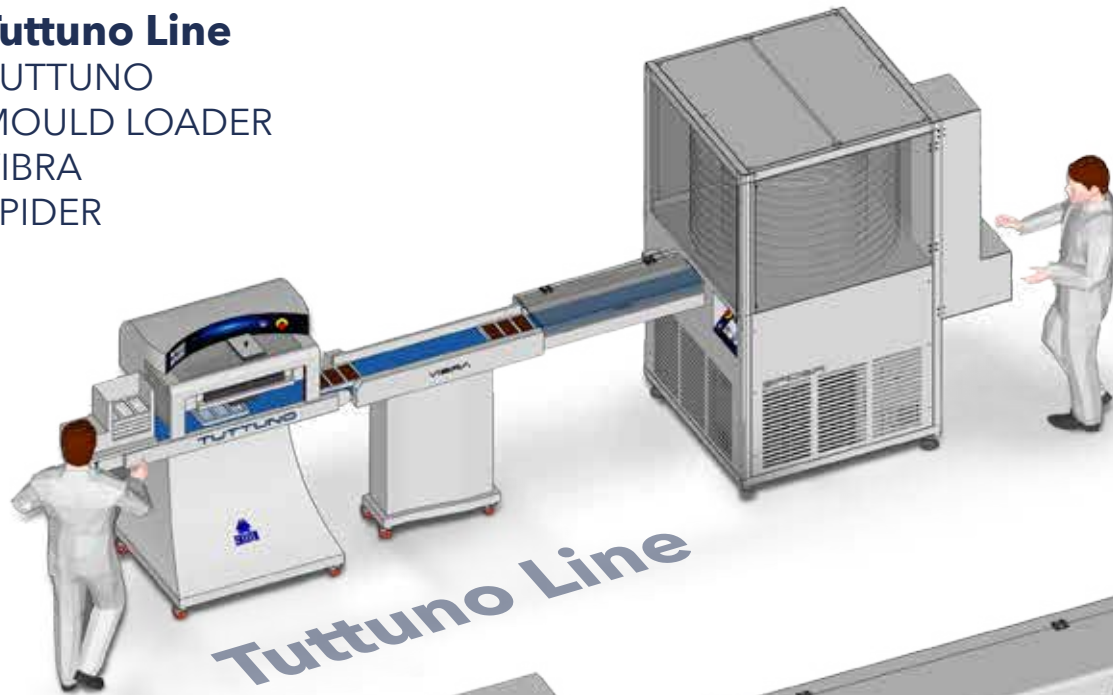

## Enrobing Line

TOP EX  
R300  
TUNNEL 5 mt - 300 mm  
BELT  
DETACHMENT



Total price ex-works € 119.000,00